

92x92x25 mm

24 V



General Specifications

- **Material:**
 - Frame: Plastics (Flammability: UL 94V-0)
 - Impeller: Plastics (Flammability: UL 94V-1)
- **Expected Life:** 40,000 h (L10:Survival rate: 90% at 60 °C, rated voltage, and continuously run in a free air state)
- **Lead Wire:** ⊕ red ⊖ black or blue
- **Storage Temperature:** -30 °C to +70 °C (Non-condensing)
- **Ball bearings**
- **International Standards:** UL/CSA, TÜV, RoHS

Air Flow - Static Pressure Characteristics

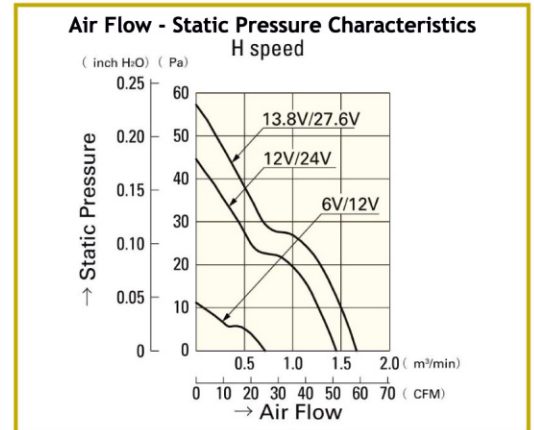

Specifications

Model No.	Rated Voltage [V]	Operating Voltage Range [V]	Rated Current [A]	Rated Input [W]	Rated Speed [min ⁻¹]	Max. Air Flow [m ³ /min] [CFM]	Max. Static Pressure [Pa] [inchH ₂ O]	SPL [dB(A)]	Operating Temperature [°C]	Expected Life [h]
9A0924H402	24	12 to 27.6	0.1	2.4	3,150	1.45 51.2	44 0.177	33	-20 to +70	40,000/60*

Dimensions (Unit:mm)

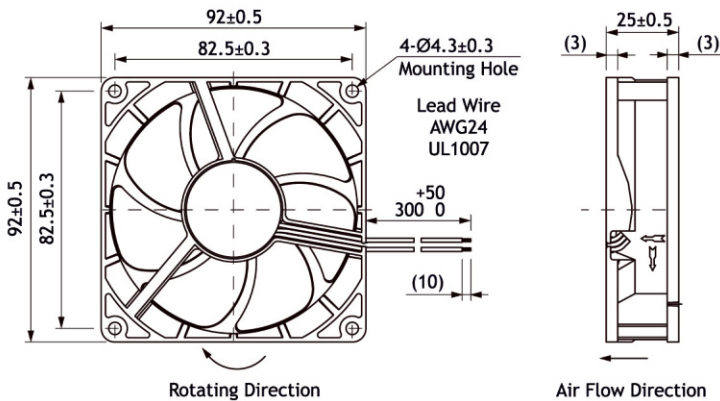

Reference dimension of mounting holes and vent opening (Unit: mm)

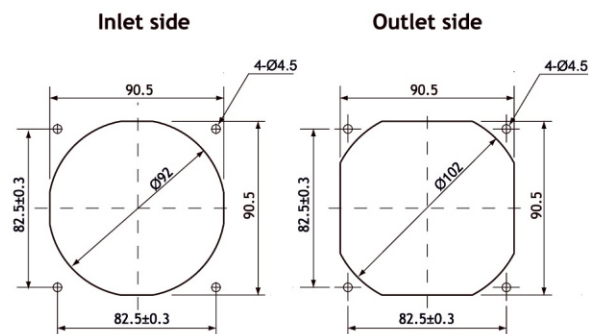

92 mm sq.



- Model always available on stock at R.T.A.
- Also available for online purchasing at www.rta-store.com

