

HI-MOD ETS Combo Unit



INTRODUCTION

HI-MOD ETS is a series of stepping motors in three sizes with integrated ministep bipolar chopper EtherCAT drives and STO Function, based on incremental or battery-less multi-turn absolute encoder.

HIGHLIGHTS

- New generation Full Closed Loop Absolute Encoder versions available
- Holding Torque up to 920 Ncm
- Communication by means of EtherCAT interface
- Different Operation Modes
- Available Inputs / Outputs
- Different HOMING operation modes
- PROXIMITY hardware input
- AUTO-SYNC function
- Battery-less Multi-turn ABSOLUTE ENCODER versions
- STO Function - SIL3 with Error Detection Monitor

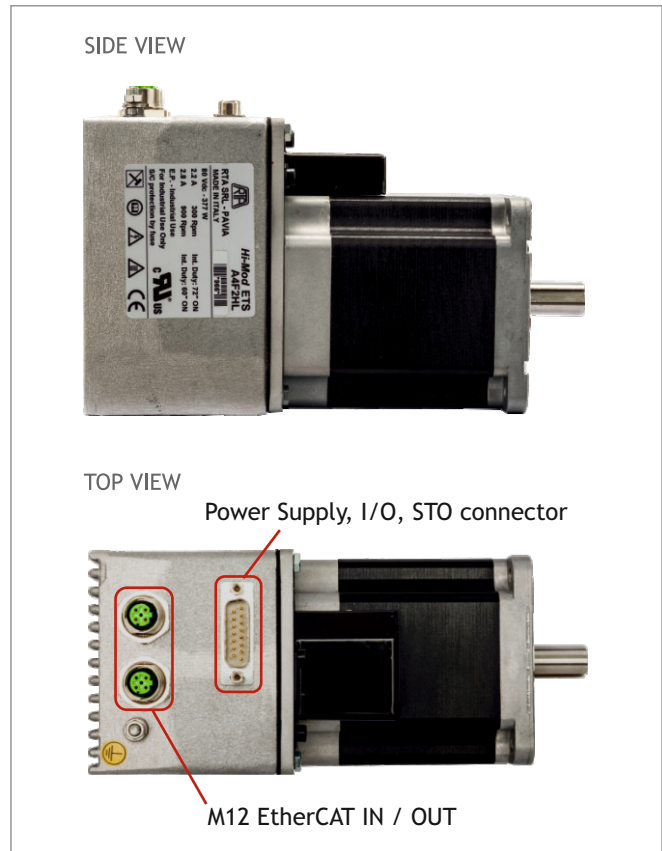

Front Brake and/or Gearbox versions available

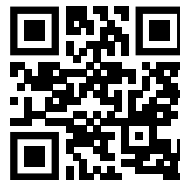
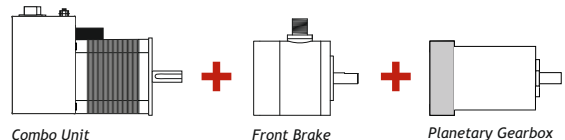

SCAN THE QR CODE TO WATCH A VIDEO ON THE AUTO-SYNC FUNCTION



Please refer to download.rta.it for technical specifications

Models	Motor Length (mm)	Holding Torque (Ncm)	Encoder Type	Digital In/Out	STO In	Certifications
HI-MOD ETS A4F2HK <i>Full Closed Loop</i>	96.5	700	Battery-less Multi-turn Absolute	2/2	2	CE, UL, CSA + STO SIL3
HI-MOD ET A5F2HK <i>Full Closed Loop</i>	96.5	700	Battery-less Multi-turn Absolute	2/2	/	CE, UL, CSA
HI-MOD ETS E4F2HC	96.5	700	Incremental	2/2	2	CE, UL, CSA + STO SIL3
HI-MOD ET E3F2HA	96.5	700	Incremental	1/0	/	CE

SIZES AND PERFORMANCES

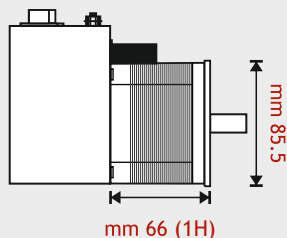

mm 66 (1H)
Holding Torque: 360 Ncm

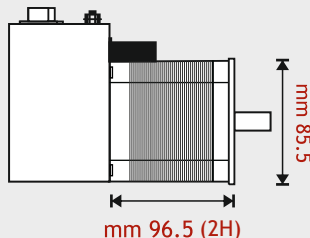

mm 96.5 (2H)
Holding Torque: 700 Ncm

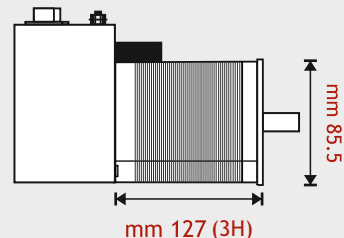

mm 127 (3H)
Holding Torque: 920 Ncm

CONNECTION SCHEME

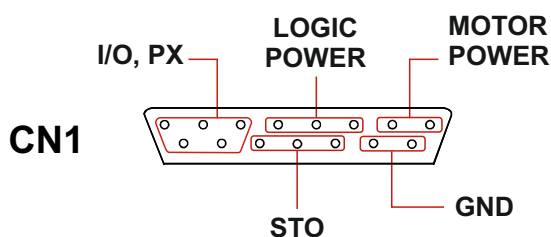

CN2



EtherCAT
OUT
(Female)

CN3



EtherCAT
IN
(Female)

- 1: Trasmit Data +
- 2: Receive Data +
- 3: Trasmit Data -
- 4: Receive data -

TORQUE/SPEED CURVE

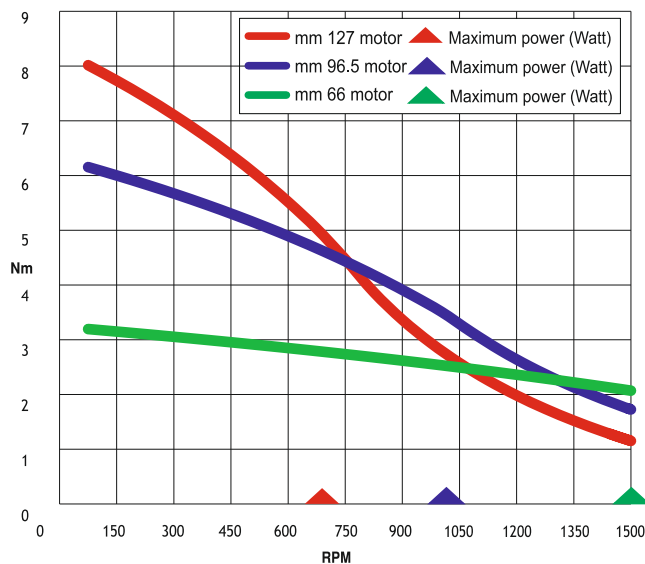

MECHANICAL DIMENSIONS (mm)

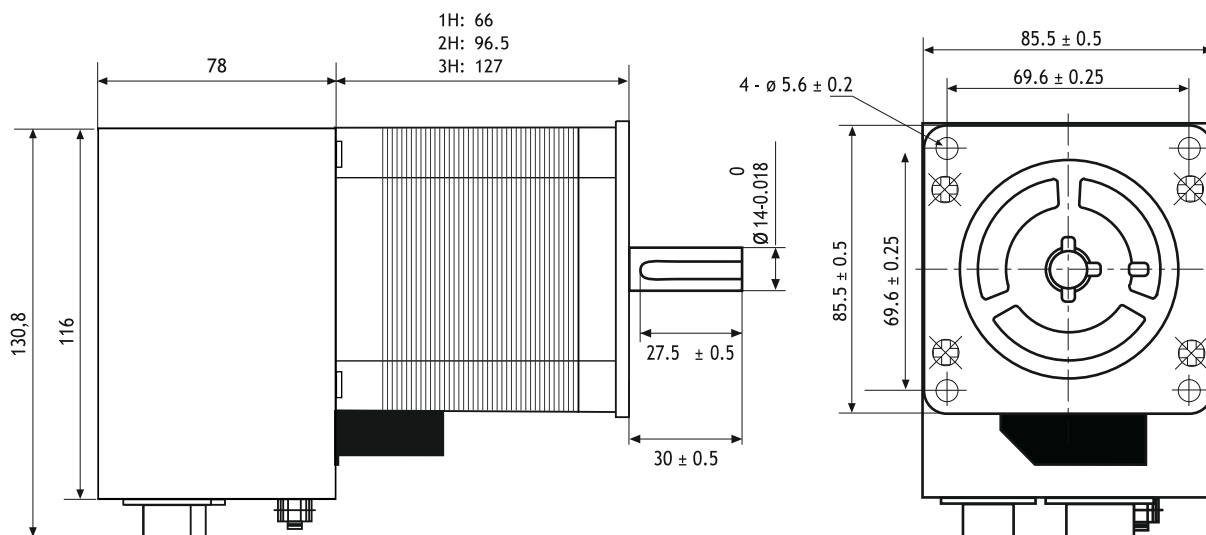

Starter kit and cable set available.



R.T.A. s.r.l.
Via E. Mattei - Frazz. Divisa
27020 Marcignago (PV) (Italy)
T +39.0382.929.855
F +39.0382.929.150
www.rta.it

R.T.A. Deutschland GmbH
Bublitzer Strasse 34, 40599
Duesseldorf (Germany)
T +49.211.749.668.60
F +49.211.749.668.66
www.rta-deutschland.de

R.T.A. IBERICA
C/Generalitat 22, Local 1
08850 Gava - Barcelona (Spain)
T +34 936.388.805
F +34 936.334.595
www.rta-iberica.es

R.T.A. INDIA Pvt
Teerth Business Center 3rd Floor, Unit No. 7,
Block EL-15, MIDC Bhosari Pimpri-Chinchwad,
Pune 411026 (India)
Tel. +91 9422507445
www.rta-india.in