

# HI-MOD ETS Combo Unit

3rd  
FIRMWARE  
GENERATION

## EtherCAT®

### INTRODUCTION

HI-MOD ETS is a series of stepping motors in three sizes with integrated ministepp bipolar chopper EtherCAT drives and STO Function, based on incremental or battery-less multi-turn absolute encoder.

### HIGHLIGHTS

- New generation Full Closed Loop Absolute Encoder versions available
- Holding Torque up to 920 Ncm
- Communication by means of EtherCAT interface
- Different Operation Modes
- Available Inputs / Outputs
- Different HOMING operation modes
- PROXIMITY hardware input
- AUTO-SYNC function
- Battery-less Multi-turn ABSOLUTE ENCODER versions
- STO Function - SIL3 with Error Detection Monitor

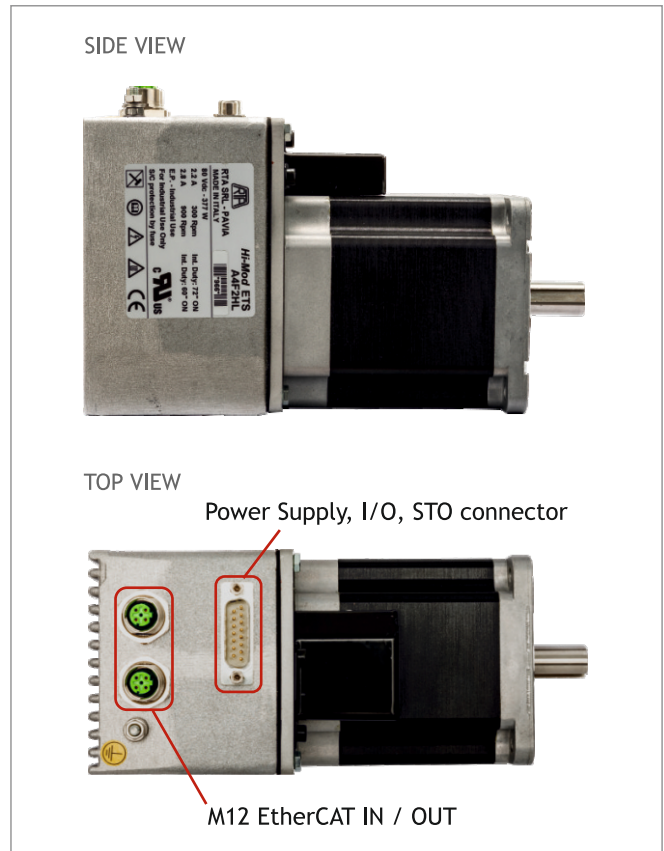

Front Brake and/or Gearbox versions available

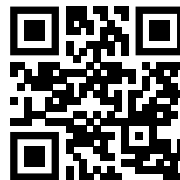
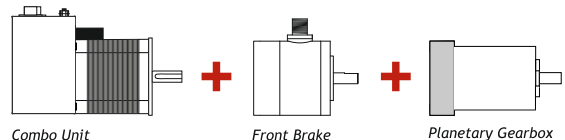

SCAN THE QR CODE TO  
WATCH A VIDEO ON THE  
AUTO-SYNC FUNCTION



Please refer to [download.rta.it](http://download.rta.it) for technical specifications

Models	Motor Length (mm)	Holding Torque (Ncm)	Encoder Type	Digital In/Out	STO In	Certifications
HI-MOD ETS A4F2HK <i>Full Closed Loop</i>	96.5	700	Battery-less Multi-turn Absolute	2/2	2	CE, UL, CSA + STO SIL3
HI-MOD ET A5F2HK <i>Full Closed Loop</i>	96.5	700	Battery-less Multi-turn Absolute	2/2	/	CE, UL, CSA
HI-MOD ETS E4F2HC	96.5	700	Incremental	2/2	2	CE, UL, CSA + STO SIL3
HI-MOD ET E3F2HA	96.5	700	Incremental	1/0	/	CE

## SIZES AND PERFORMANCES

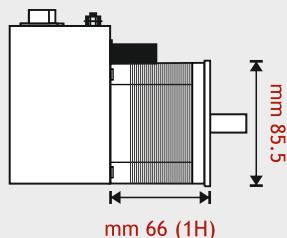

mm 66 (1H)  
Holding Torque: 360 Ncm

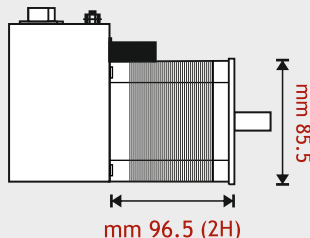

mm 96.5 (2H)  
Holding Torque: 700 Ncm

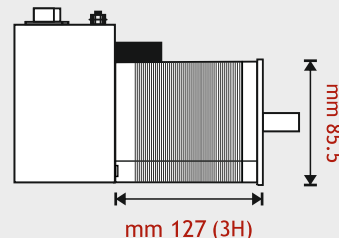

mm 127 (3H)  
Holding Torque: 920 Ncm

## CONNECTION SCHEME

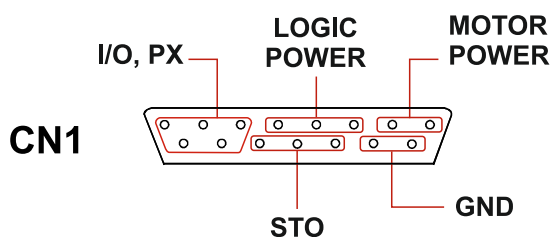

- 1: Trasmit Data +
- 2: Receive Data +
- 3: Trasmit Data -
- 4: Receive data -

## TORQUE/SPEED CURVE

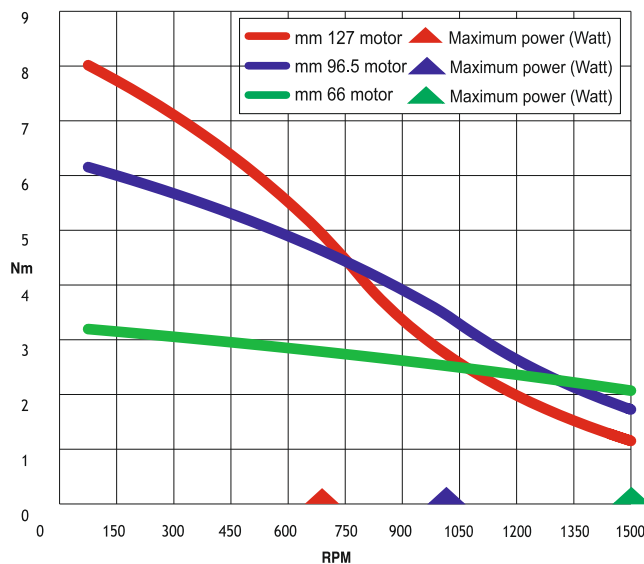

## MECHANICAL DIMENSIONS (mm)

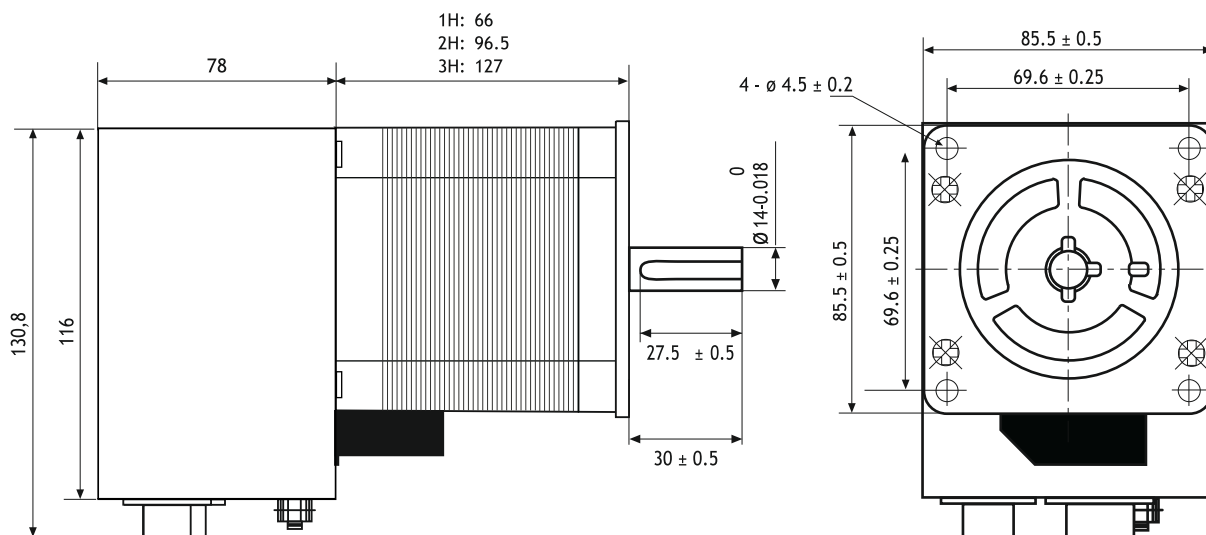

*Starter kit and cable set available.*



R.T.A. s.r.l.  
Via E. Mattei - Fraz- Divisa  
27020 Marcignago (PV) (Italy)  
T +39.0382.929.855  
F +39.0382.929.150  
www.rta.it

R.T.A. Deutschland GmbH  
Bublitzer Strasse 34, 40599  
Duesseldorf (Germany)  
T +49.211.749.668.60  
F +49.211.749.668.66  
www.rta-deutschland.de

R.T.A. IBERICA  
C/Generalitat 22, Local 1  
08850 Gava - Barcelona (Spain)  
T +34 936.388.805  
F +34 936.334.595  
www.rta-iberica.es

R.T.A. INDIA Pvt  
Teerth Business Center 3<sup>rd</sup> Floor, Unit No. 7,  
Block EL-15, MIDC Bhosari Pimpri-Chinchwad,  
Pune 411026 (India)  
Tel. +91 9422507445  
www.rta-india.in